

Typical Features

- ◆ Wide input voltage range 4:1
- ◆ Efficiency 91% (Typ.)
- ◆ Low standby power consumption
- ◆ Operating temperature from -40°C to +105°C
- ◆ High isolation voltage 3000VDC (input-output) & 2100VDC (input-case)
- ◆ Input under voltage protection, output over current, over voltage, over temp. & short circuit protections
- ◆ Parallel Operation with Current Sharing
- ◆ Standard full brick size

The **ZAD600-110S28A** series consists of high-performance full-brick DC-DC converters featuring a 110VDC rated input (43-160VDC range) and a regulated single output with no minimum load requirement. Providing high isolation and operating temperatures up to 105°C, the series includes comprehensive protections against input undervoltage, output overcurrent, overvoltage, overtemperature, and short circuits, plus Remote Control (CNT), Remote Sense, and output voltage trimming.

Selection Guide							
Part No.	Input voltage range (VDC)	Output Power (W)	Output Voltage (VDC)	Output Current (A)	Ripple & Noise (mVp-p)	Full load Efficiency (%) Min/Typ.	Remark
ZAD600-110S28A	43-160	600	28	21.4	280	89/91	Standard, Positive Logic
ZAD600-110S28AN							Standard, Negative Logic
ZAD600-110S28A-H							Heatsink, Positive Logic
ZAD600-110S28AN-H							Heatsink, Negative Logic

Note: For input below 66V, the output power derates linearly; at 43V, the output power is 400W.

Input Specifications						
Item	Operating Conditions	Min.	Typ.	Max.	Unit	
Max. Input Current	43 Vdc input voltage, full-load output	--	--	12	A	
No-load Input Current	Rated input voltage	--	--	20	mA	
Input Transient Voltage (1 sec. max.)	Exceeding this range causes permanent damage	-0.7	--	185	VDC	
Input Overvoltage Protection (OVP)		--	--	180		
Input Overvoltage Recovery		160	--	--		
Start-up Voltage		--	--	43		
Input Undervoltage Protection (UVP)	No-load test; full-load test will trigger overcurrent protection early	--	--	42		
Remote ON/OFF (CNT)	Positive Logic: The module turns ON when CNT is open or connected to 3.5-15V; it turns OFF when connected to 0-1.2V.					Reference Voltage: -Vin
	Negative Logic: The module turns OFF when CNT is open or connected to 3.5-15V; it turns ON when connected to 0-1.2V.					

Output Specifications					
Item	Operating Conditions	Min.	Typ.	Max.	Unit
Output Voltage Accuracy	Nominal Input Voltage, 0%–100% load	--	±0.5	±1.0	%
Line Regulation	Full load, input voltage from low to high	--	±0.1	±0.2	
Load Regulation	Nominal Input Voltage, with load ranging from 10% to 100%	--	±0.1	±0.2	
Transient Recovery Time	25% load step change (step rate 1 A/50 μs)	--	200	250	μs
Transient Response Deviation		-5	--	5	%
Temperature Coefficient	Full load	-0.02	--	+0.02	%/°C
Ripple & Noise	20MHz Bandwidth, with ext. cap. >470μF or higher	--	200	280	mVp-p
Output voltage adjustable (TRIM)		-20	--	+10	%
Remote Sense for output voltage		--	--	105	%
Over Temperature Protection(OTP)	Max Baseplate Temperature	105	115	125	°C
Output Overvoltage Protection(OVP)		125	--	140	%
Output Over-current Protection (OCP)		23	--	28	A
Output Short-circuit Protection (SCP)		Hiccup mode, Continuous, Auto-recovery			

General Specifications						
Item	Operating conditions		Min.	Typ.	Max.	Unit
Isolation Voltage	I/P-O/P	Test 1min, leakage current <3mA	3000	--	--	VDC
	I/P-Case	Test 1min, leakage current <3mA	2100	--	--	VDC
	O/P-Case	Test 1min, leakage current <3mA	500	--	--	VDC
Insulation Resistance	I/P-O/P	@ 500VDC	100	--	--	MΩ
Switching Frequency			--	260	--	kHz
MTBF			150	--	--	khrs

Environmental Specifications						
Item	Operating conditions		Min.	Typ.	Max.	Unit
Operating Temperature	Refer to the temperature derating curve		-40	--	+105	°C
Storage Humidity	No-condensing		5	--	95	%RH
Storage Temperature			-40	--	+125	°C
Pin Soldering Temperature	≥ 1.5mm from case, < 1.5s		--	--	+350	
Cooling Requirement			EN60068-2-1			
Dry Heat			EN60068-2-2			
Damp Heat			EN60068-2-30			
Vibration & Shock			IEC/EN 61373 Category 1, Class B			

EMC Performance					
EMI	CE	EN50121-3-2	150kHz-500kHz 79dBuV		
		EN55016-2-1	500kHz-30MHz 73dBuV		
	RE	EN50121-3-2	30MHz-230MHz 40dBuV/m at 10m		
		EN55016-2-1	230MHz-1GHz 47dBuV/m at 10m		
EMS	ESD	IEC/EN61000-4-2/GB/T 17626.2-2006	Contact ±6KV/Air ±8KV		Performance Criteria A
	RS	IEC/EN61000-4-3/GB/T 17626.3-2006	10V/m		Performance Criteria A
	EFT	IEC/EN61000-4-4/GB/T 17626.4-2008	±2kV 5/50ns 5kHz		Performance Criteria A
	Surge	IEC/EN61000-4-5/GB/T 17626.5-2008	Line to line ± 1KV (42Ω, 0.5μF)		Performance Criteria A
	CS	IEC/EN61000-4-6/GB/T 17626.6-2008	0.15MHz-80MHz 10 Vr.m.s		Performance Criteria A

Physical Specifications

Case Material	Metal base + black flame-retardant plastic (UL94-V0)
Heat Sink	Dimensions: Dimensions: 116.8 x 61 x 20 mm, Weight: 135g, Aluminum alloy, black anodized; Black
Cooling Method	Conduction cooling or forced air cooling
Unit Weight	Standard: 250g; With heat sink: 389g

Mechanical Dimensions and Pin Definition

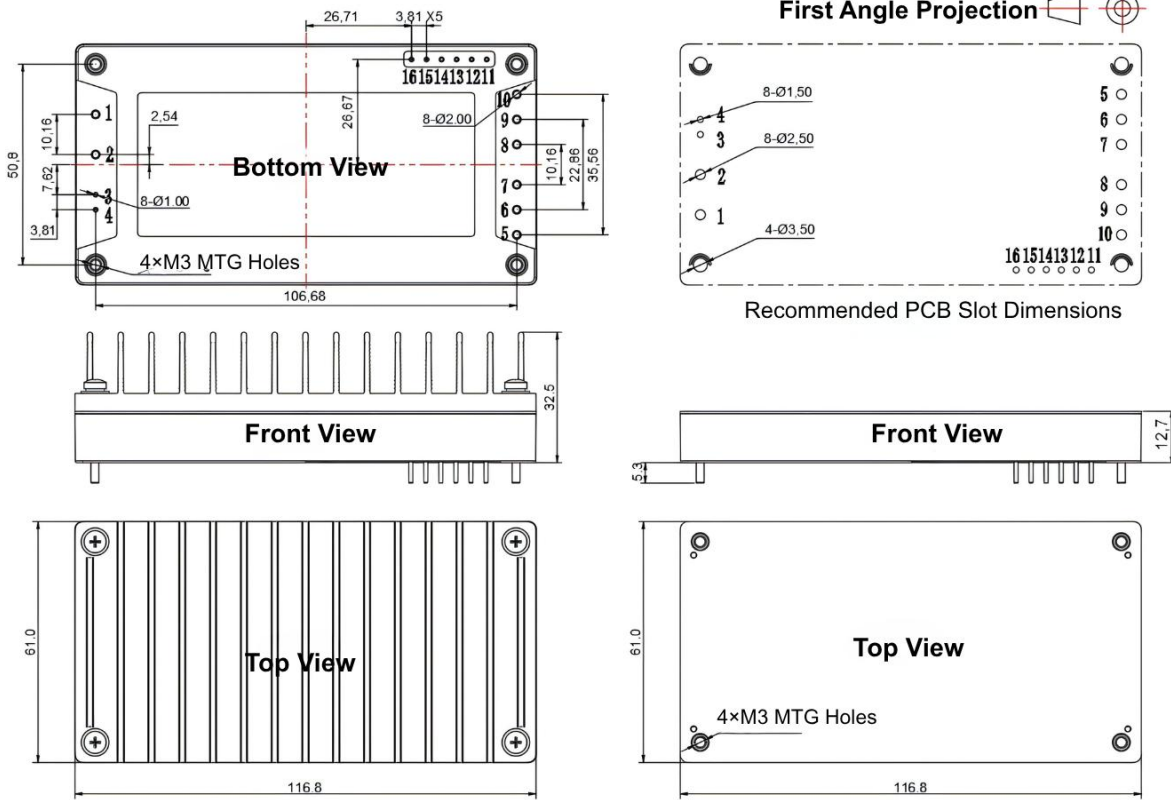

Standard + Heat sink
116.8*61.0*32.50mm

Standard
116.8*61*12.7mm

Note:

- Unit: mm
- Pin 1, 2, 5, 6, 7, 8, 9,10 diameter: 2.00mm
- Pin 3,4,11,12,13,14,15,16 diameter: 1.0mm
- Tolerance: X.X ±0.50 mm, X.XX ±0.10 mm
- Mounting Torque: 0.4 N·m (Max.)

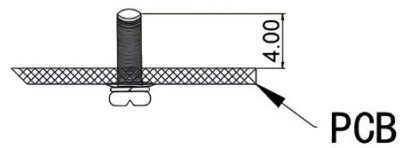

No.	1	2	3	4	5	6	7	8	9	10
Pin Definitions	-Vin	+Vin	CNT	NC	Vout+	Vout+	Vout+	Vout-	Vout-	Vout-
Function	Input Negative	Input Positive	Remote Control	No Connection	Output Positive	Output Positive	Output Positive	Output Negative	Output Negative	Output Negative
No.	11	12	13	14	15	16				
Pin Definitions	-Sense	+Sense	TRIM	PC	IOG	AUX				
Function	Remote Sense Negative	Remote Sense Positive	Output Voltage Trimming	Parallel Control (Current Sharing)	Output Status	Auxiliary Power Supply				

Note: 1. IOG is the output status signal, showing low impedance during normal operation and high impedance during abnormal operation (Max sink current 10mA); 2. AUX is the auxiliary power supply providing 12V during normal operation (Max output current 10mA).

Typical Characteristic Curves

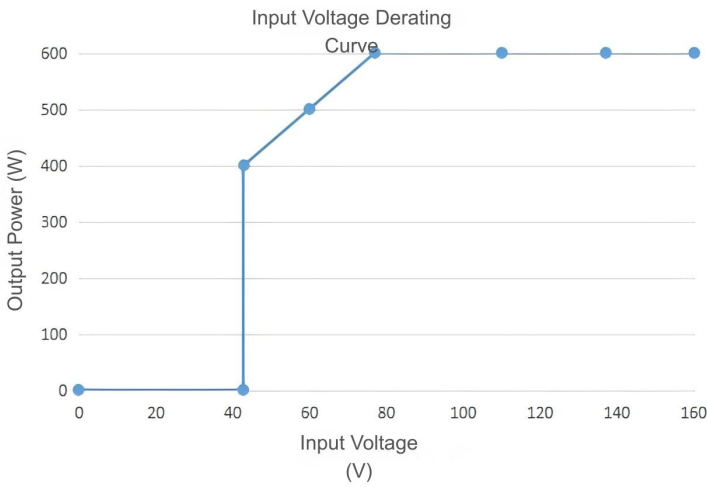
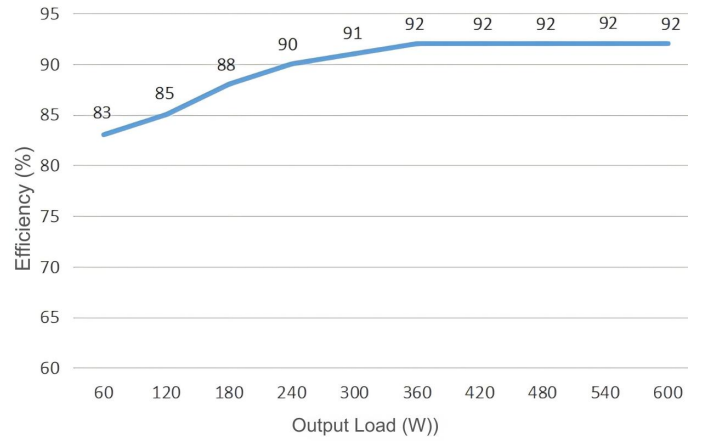
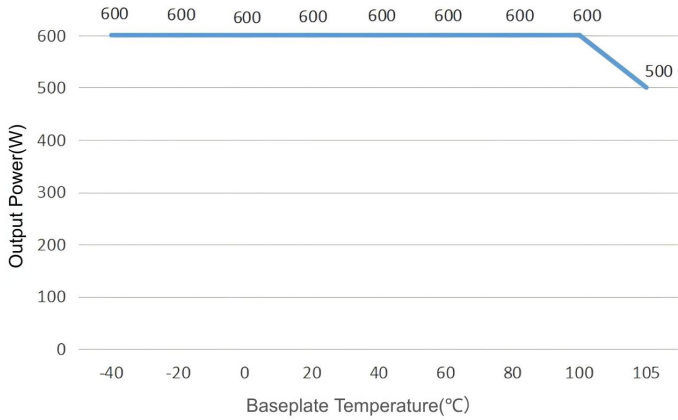

Notes:

1. The derating and efficiency curves are based on typical test values.
2. Temperature derating curves are obtained under Aipu's laboratory test conditions. If the actual application environment differs, the product can be used within any rated load range provided the case temperature (metal base) is maintained below 100°C.

Recommended circuits for application

1. Ripple & Noise

All DC-DC converters in this series are tested according to the recommended test circuit diagram shown below prior to shipment.

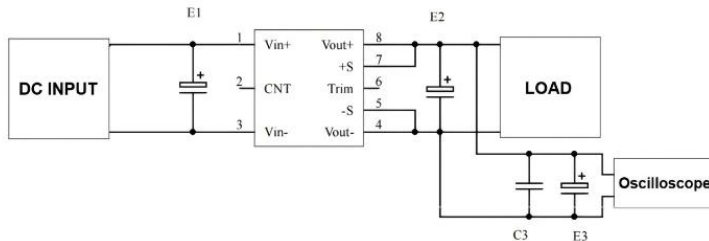

Capacitance Output Volt.	E1 (μF)	E2 (μF)	C3 (μF)	E3 (μF)
3.3VDC	100	1000	1	10
5VDC		680		
12VDC		220		
.....	68	68	1	10
48VDC		68		
.....				
110VDC				

2. Recommended circuit for application

If the recommended circuit is not used, an electrolytic capacitor of at least 100μF must be connected in parallel at the input side to suppress potential surge voltage.

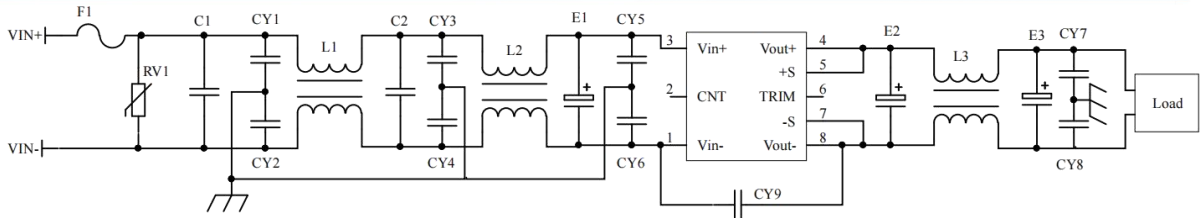

F1	T15A/250V FUSE
RV1	14D 200V Varistor(MOV)
C1, C2	105/250V Polyester film capacitor
CY1, CY2, CY3, CY4, CY5, CY6	102/250Vac Safety Y2 capacitor
CY7, CY8	103/2KV Ceramic capacitor
CY9	471/250Vac Safety Y2 capacitor
E1	220 μ F/200V Electrolytic capacitor
E2, E3	470 μ F/35V Electrolytic capacitor
L1, L2	Inductance > 5mH, Rated Current 12A, Temperature Rise < 25 $^{\circ}$ C
L3	Inductance > 0.2mH, Rated Current 22A, Temperature Rise < 25 $^{\circ}$ C

3. Recommended Applications for Remote Control (CNT)

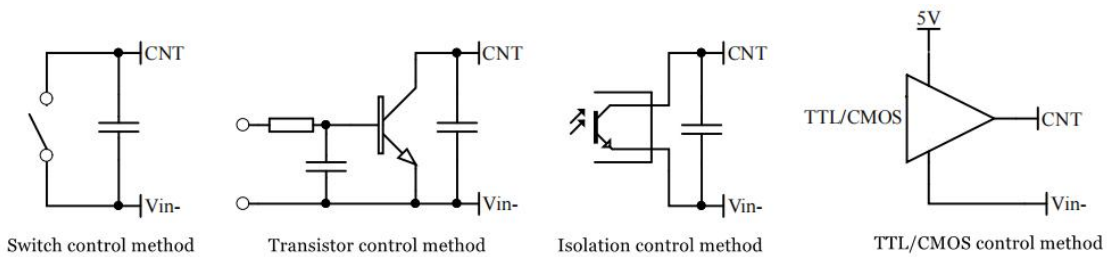

4. Remote Sense Application and Precautions

1) Without Remote Sense

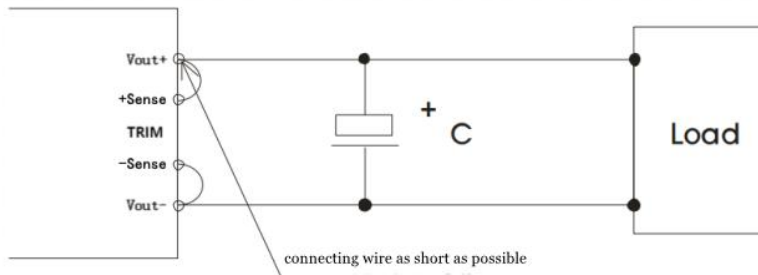

Note:

1. When remote sense is not in use, ensure +Vout is shorted to +Sense, and -Vout to -Sense.
2. The connections between +Vout to +Sense and -Vout to -Sense must be as short as possible and located close to the pins; otherwise, it may cause module instability.

2) With Remote Sense

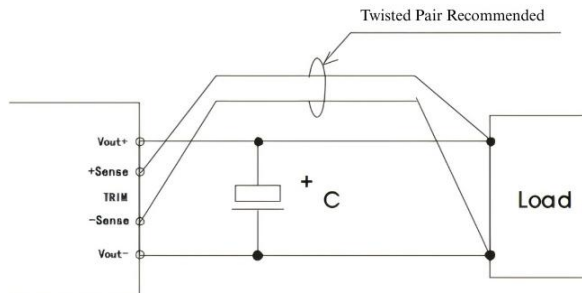

Notes:

1. Long lead wires for remote sense may result in output voltage instability.
2. Twisted pair or shielded wires are recommended; keep the lead length as short as possible.
3. Use wide PCB traces or thick wires between the power module and the load to ensure the line voltage drop is below 0.3V. This maintains the output voltage within the specified range.
4. Lead impedance may cause output voltage oscillation or excessive ripple; please verify performance thoroughly before use.

5. Output Voltage Trim Range vs. Resistor Value

Output Voltage Trim Range vs. Resistor Value

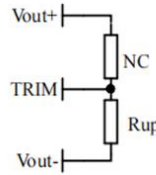

Voltage-up: Add Rup between Trim and Vout-

$$R_{up} = 127.5 / (\Delta U - 10) \text{ (K}\Omega\text{)}$$

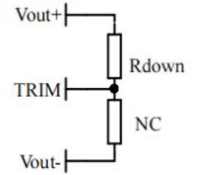

Voltage-down: Add Rdown between Trim and Vout+

$$R_{down} = 51 * (25.5 - \Delta U) / (\Delta U - 10) \text{ (K}\Omega\text{)}$$

6. Parallel Configuration for Increased Power

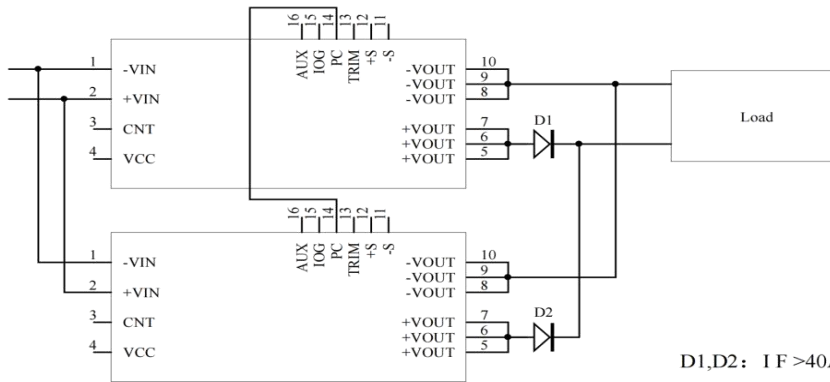

D1,D2: 1F >40A

Others

1. The product warranty period is two years. Defective products will be repaired or replaced free of charge under normal operating conditions. Paid services are available for damages resulting from improper use or technical operating errors.
2. AIPUPOWER provides customized designs and matching filter modules. Please contact our technical support team for detailed information.
3. Updated: 2026/04/15

Guangzhou Aipu Electron Technology Co., Ltd

Address: Building 4, HEDY Park, No.63, Punan Road, Huangpu Dist, Guangzhou, China.

Tel: 86-20-84206763 Fax: 86-20-84206762 HOTLINE: 400-889-8821

E-mail: sales@aipu-elec.com Website: <https://www.aipupower.com>